

détail profil 20-12

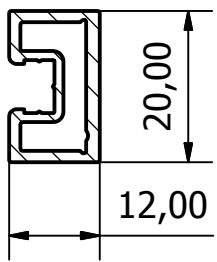

détail clips dessus ou latéral

clips 6, 9, 11, 16,
18, 21 ou autres

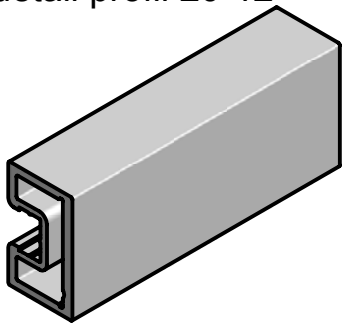
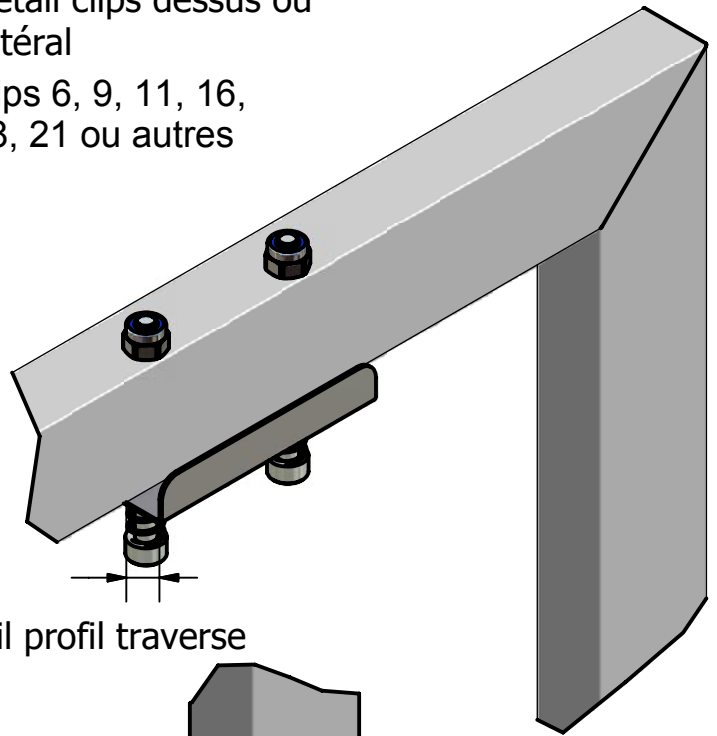

détail profil traverse

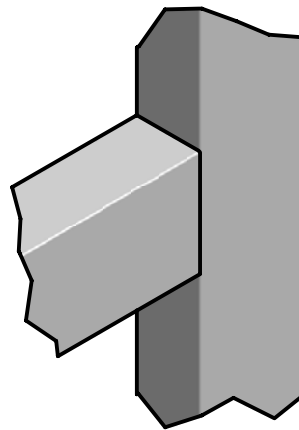

détail clips dessous ou latéral

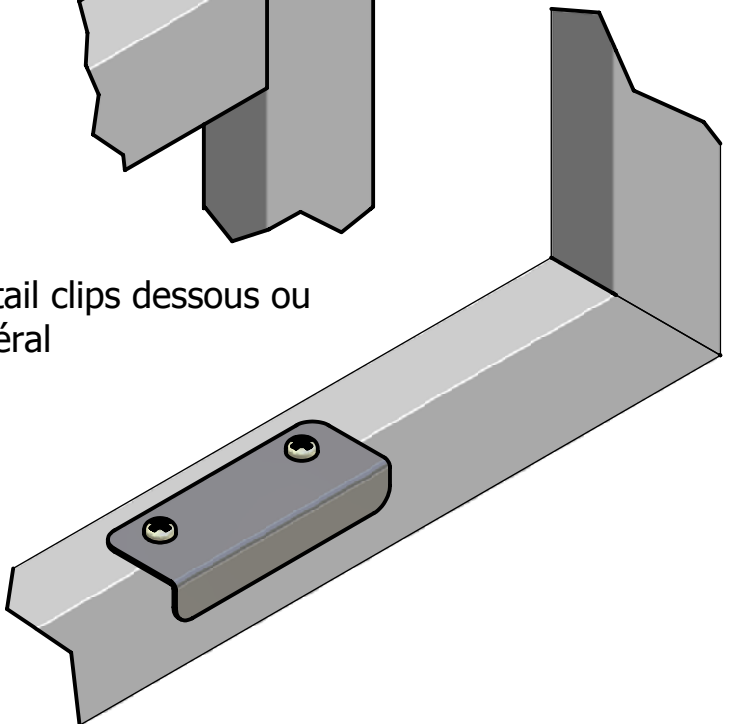

Possibilités de fixation :



clips

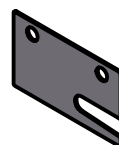

ou verrou

